

Apple II

Monitor II User's Manual

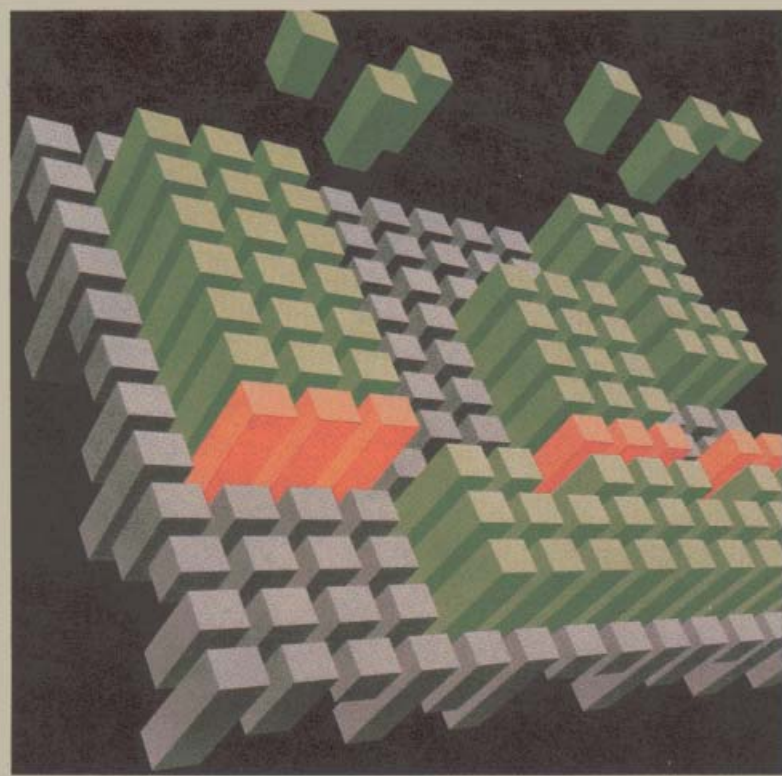

Customer Satisfaction

If you discover physical defects in the manuals distributed with an Apple product or in the media on which a software product is distributed, Apple will replace the documentation or media at no charge to you during the 90-day period after you purchased the product.

In addition, if Apple releases a corrective update to a software product during the 90-day period after you purchased the software, Apple will replace the applicable diskettes and documentation with the revised version at no charge to you during the six months after the date of purchase.

In some countries the replacement period may be different; check with your authorized Apple dealer. Return any item to be replaced with proof of purchase to Apple or an authorized Apple dealer.

Limitation on Warranties and Liability

Even though Apple has tested the software described in this manual and reviewed its contents, neither Apple nor its software suppliers make any warranty or representation, either express or implied, with respect to this manual or to the software described in this manual, their quality, performance, merchantability, or fitness for any particular purpose. As a result, this software and manual are sold "as is," and you the purchaser are assuming the entire risk as to their quality and performance. In no event will Apple or its software suppliers be liable for direct, indirect, incidental, or consequential damages resulting from any defect in the software or manual, even if they have been advised of the possibility of such damages. In particular, they shall have no liability for any programs or data stored in or used with Apple products, including the costs of recovering or reproducing these programs or data. Some states do not allow the exclusion or limitation of implied warranties or liability for incidental or consequential damages, so the above limitation or exclusion may not apply to you.

Copyright

This manual and the software (computer programs) described in it are copyrighted by Apple or by Apple's software suppliers, with all rights reserved. Under the copyright laws, this manual or the programs may not be copied, in whole or part, without the written consent of Apple, except in the normal use of the software or to make a backup copy. This exception does not allow copies to be made for others, whether or not sold, but all of the material purchased (with all backup copies) may be sold, given or loaned to another person. Under the law, copying includes translating into another language.

You may use the software on any computer owned by you but extra copies cannot be made for this purpose. For some products, a multi-use license may be purchased to allow the software to be used on more than one computer owned by the purchaser, including a shared-disk system. (Contact your authorized Apple dealer for information on multi-use licenses.)

Product Revisions

Apple cannot guarantee that you will receive notice of a revision to the software described in this manual, even if you have returned a registration card received with the product. You should periodically check with your authorized Apple Dealer.

© Apple Computer, Inc. 1982
20525 Mariani Avenue
Cupertino, California 95014

Apple and the Apple logo are registered trademarks of Apple Computer, Inc.

Simultaneously published in the U.S.A. and Canada.

Reorder Apple Product #A2L2019

WARNING: This equipment has been certified to comply with the limits for a Class B computing device, pursuant to Subpart J of Part 15 of FCC Rules. Only peripherals (computer input/output devices, terminals, printers, etc.) certified to comply with the Class B limits may be attached to this computer. Operation with non-certified peripherals is likely to result in interference to radio and TV reception.

Apple II

Monitor II User's Manual



Radio and Television Interference

The equipment described in this manual generates and uses radio-frequency energy. If it is not installed and used properly, that is, in strict accordance with our instructions, it may cause interference with radio and television reception.

This equipment has been tested and complies with the limits for a Class B computing device in accordance with the specifications in Subpart J, Part 15, of FCC rules. These rules are designed to provide reasonable protection against such interference in a residential installation. However, there is no guarantee that the interference will not occur in a particular installation, especially if you use a "rabbit ear" television antenna. (A "rabbit ear" antenna is the telescoping-rod type usually contained on TV receivers.)

You can determine whether your computer is causing interference by turning it off. If the interference stops, it was probably caused by the computer or its peripheral devices. To further isolate the problem:

- Disconnect the peripheral devices and their input/output cables one at a time. If the interference stops, it is caused by either the peripheral device or its I/O cable. These devices usually require shielded I/O cables. For Apple peripheral devices, you can obtain the proper shielded cable from your dealer. For non-Apple peripheral devices, contact the manufacturer or dealer for assistance.

If your computer does cause interference to radio or television reception, you can try to correct the interference by using one or more of the following measures:







- Turn the TV or radio antenna until the interference stops.
- Move the computer to one side or the other of the TV or radio.
- Move the computer farther away from the TV or radio.
- Plug the computer into an outlet that is on a different circuit than the TV or radio. (That is, make certain the computer and the radio or television set are on circuits controlled by different circuit breakers or fuses.)
- Consider installing a rooftop television antenna with coaxial cable lead-in between the antenna and TV.

If necessary, you should consult your dealer or an experienced radio/television technician for additional suggestions. You may find helpful the following booklet, prepared by the Federal Communications Commission:

"How to Identify and Resolve Radio-TV Interference Problems"

This booklet is available from the U.S. Government Printing Office, Washington, DC 20402, stock number 004-000-00345-4.

Table of Contents

	Introduction	1
	Connecting Your Monitor II	2
	Controlling and Adjusting Your Monitor II	5
	5 The On/Off Switch	
	6 The Contrast Control	
	6 The Tilting Screen Feature	
	7 Other Controls	
	7 Adjusting Contrast and Brightness	
	Care, Glare, and Don't Stare!	8
	If All Else Fails	9
	Safety Tips and Common Sense	10
	Specifications	10



Monitor II User's Manual

Introduction

Your new Monitor II is part of the growing Apple line of accessories for the Apple II family of computers. Its state-of-the-art design incorporates the following features for your viewing comfort:

- Tilting screen
- 80-column display with normal and reverse video
- Choice of amber or green display on black screen
- Nonglare screen surface
- Accurate reproduction of graphics

You'll find frequently used controls easily accessible on the front of the Monitor II. Other controls are on the back of the monitor.

Your Monitor II uses international symbols to identify controls and points of connection.

Figure 1. International Symbols for Controls and Connections

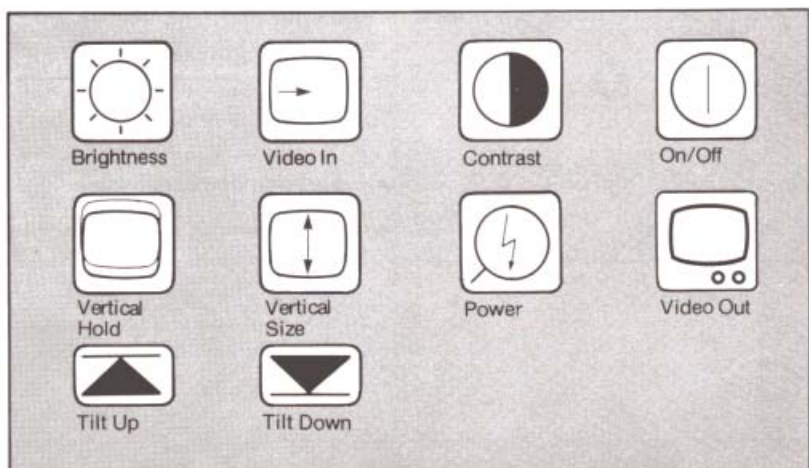

The monitor fits perfectly on top of your Apple; you can also set it on other flat, sturdy surfaces. Just be sure to leave space in back for cables.

Figure 2. Where to Put the Monitor II

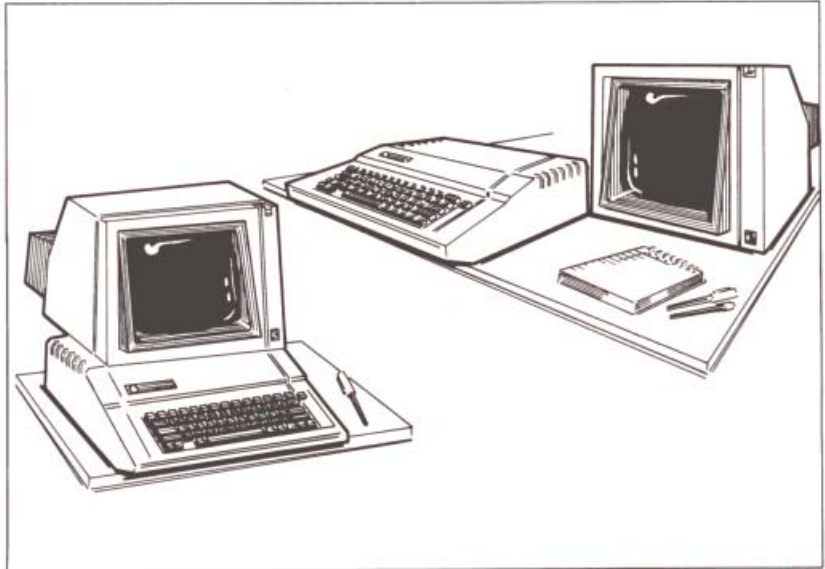

Before attaching your new monitor to the Apple, clear an area near your computer where you can place the monitor and its cables. If you're setting it on top of your Apple, allow about four inches behind the computer.

Connecting Your Monitor II

This section tells you how to connect the Monitor II to your Apple.



Warning

Be sure the computer is turned **off** before plugging any cables into it.

You need only two things to hook up your Monitor II:

- The monitor itself
- A video cable (supplied with your computer)

With the back of the monitor facing you, you'll see the power cord, three control knobs, and a small socket, or jack.

Figure 3. Points of Connection

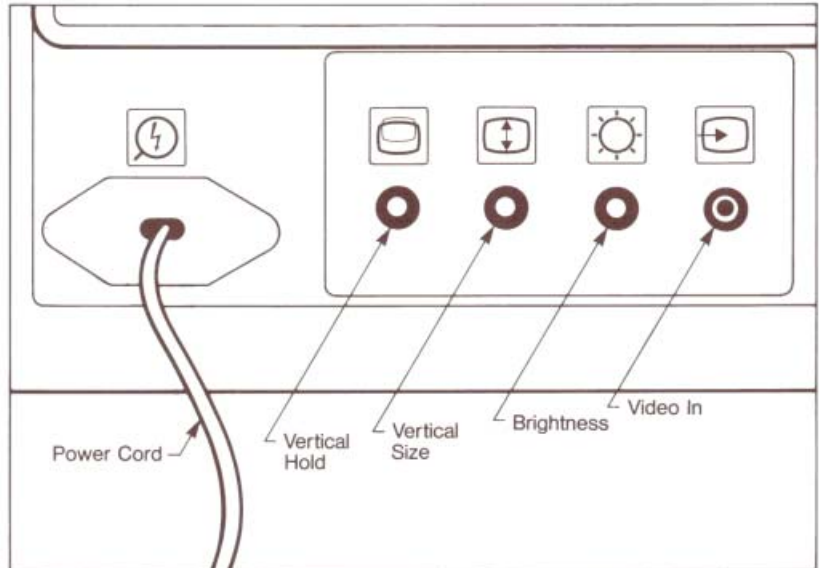

The type of jack you see is commonly referred to as an RCA or phono jack, and takes a phono-type plug. You may have seen this type of jack and plug before when connecting parts of a stereo system. In this case, the video cable supplied with your computer is what you will plug into the jack.

Figure 4. Video Cable and Jack

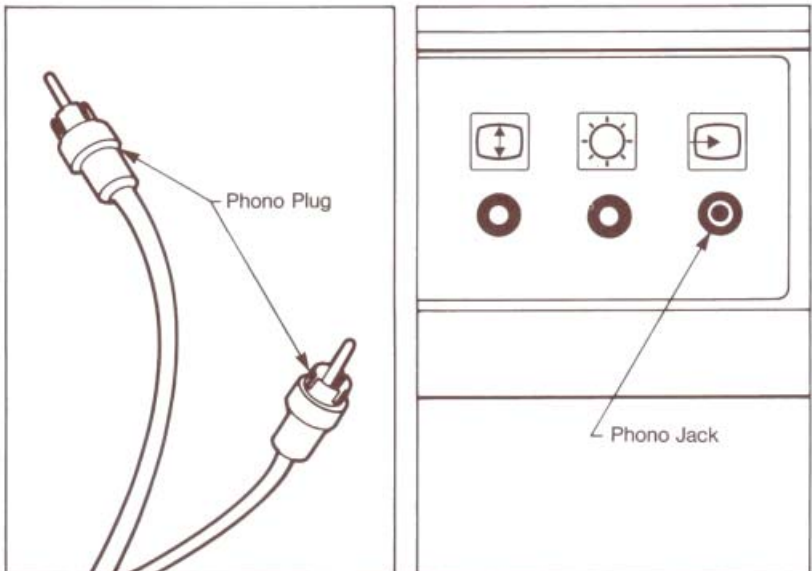

The cable connects the video signal, or the "TV picture," from the Apple to the monitor. Plug either end of the video cable firmly into the  jack on the back of the monitor. If you have any trouble inserting the cable into the jack, don't force it. Make sure that it is the right cable and that the prong is not bent.



Plug the other end of the video cable into the video output jack on the back of your computer. The figure below shows the location of the video output jack on each of the computers in the Apple II family. Notice that the video output jack on the Apple IIe is marked with the symbol .

Figure 5. Location of Video Output Jack



The other cable to be connected is the power cable, marked with the symbol , which resembles a lightning bolt. Plug the three-pronged end into a three-hole wall socket.

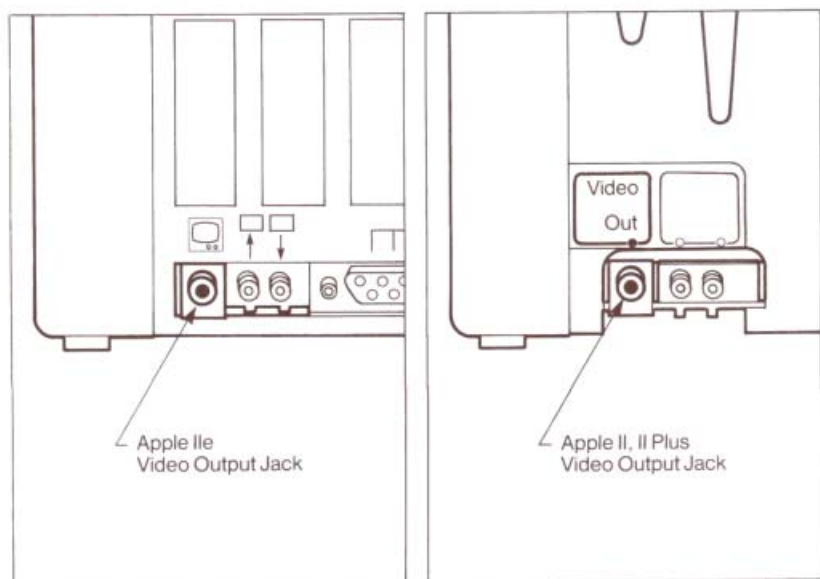

Warning

All electrical connections to your computer and peripheral equipment **must be grounded!** The electrical ground is to prevent damage to either your computer or the monitor. If your electrical outlet does not have a third, round, hole, have a qualified electrician determine if the outlet box itself is grounded (many are). If it is grounded, you can convert your outlet using an adapter available in any hardware store. This kind of adapter has a pigtail or metal tab that can be secured with the screw that holds the cover plate to the outlet.

Controlling and Adjusting Your Monitor II

The design of the Monitor II makes controlling the display and adjusting the screen easy. The most frequently used controls are

- The on/off switch
- The contrast control
- The tilting screen feature

Figure 6. Controls on the Front of the Monitor II

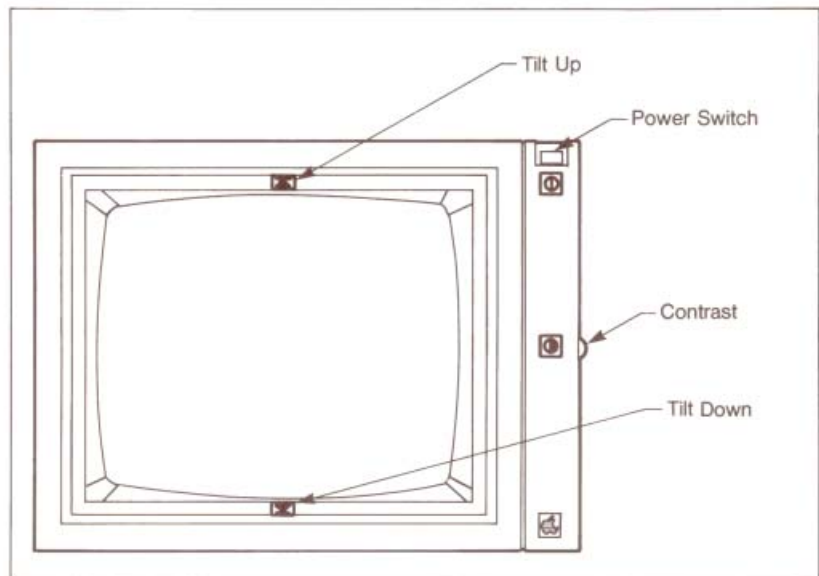

The On/Off Switch

The push-button on/off switch for the Monitor II is in the upper right-hand corner. To turn the monitor on, push the button **down**. You'll see the green light go on behind the switch. The switch stays down until you turn the monitor off.

To turn the monitor off, press the switch again. The switch will return to its raised position and the green light will go out. The light lets you know at a glance when the monitor is on.

Figure 7. The On/Off Switch and Light

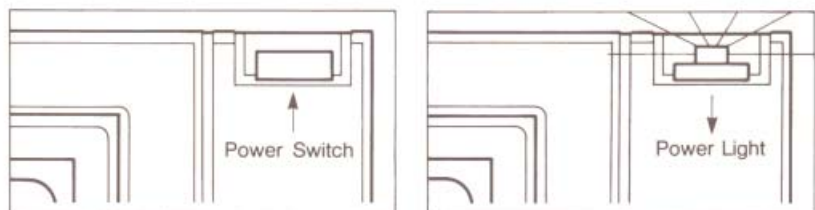

To start using your Monitor II, just insert a program disk into disk drive 1 and turn on both the monitor and the Apple.

By the Way: If you're a first-time Apple user, your computer owner's manual will help you with full instructions on getting your Apple up and running. If you own an Apple IIe, we suggest you use "Apple Presents Apple," the keyboard introduction disk that comes with it.

Soon some text should appear on the screen of your monitor. If your screen is still blank after a moment, refer to "If All Else Fails" in the back of this manual.

The Contrast Control

The contrast control is labeled . Rotating it increases or decreases the degree of difference between the lightest and darkest sections on the screen.

The Tilting Screen Feature

The tilting screen is another special design feature of the Monitor II. You can select the ideal screen position—perpendicular to your line of vision—depending on your size and the height of your table.

The arrows at the top and bottom of the monitor indicate the direction in which the screen tilts. To adjust the screen to your comfort, press the top or bottom of the screen rim. Avoid touching the screen itself. Pushing in the top rotates the screen up, while pressing the bottom moves the screen downward.

As the screen moves, you will feel and hear a series of clicks. These are feedback clicks that indicate each degree of arc through which the screen is tilted.

Figure 8. Line of Vision and Perpendicularity of Screen



Other Controls

There are three controls on the back of the monitor, placed there because you will seldom need to adjust them. They are



- The vertical hold control,  , which brings up/down rolling under control;
- The vertical size control,  , which lengthens or shortens the vertical height of the picture;
- The brightness control,  , which controls the brightness of the picture.

Figure 9. Controls on the Back of the Monitor II



Adjusting Contrast and Brightness

With the computer and monitor on and text on the screen, turn the contrast control all the way clockwise. Then turn the brightness control clockwise until the background lines on the screen are clearly visible. Now turn the brightness control counterclockwise until the fine lines just disappear. Finally, adjust the contrast control to give a pleasing level of text illumination.

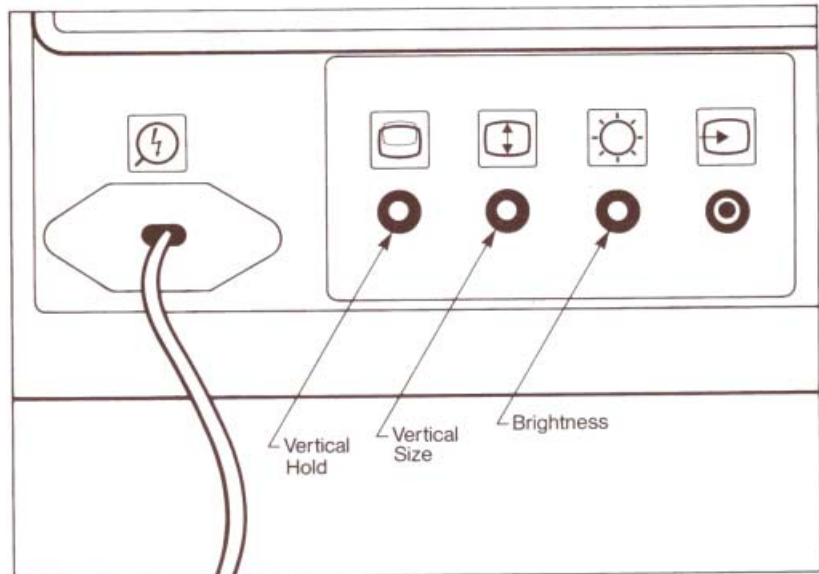
Care, Glare, and Don't Stare!

Your new monitor is tough and can take some heavy knocks, but don't abuse it! Please don't place any spillables on the monitor. Coffee, cola, or chicken soup can ruin the monitor, and the computer as well.



Warning

The Monitor II's vents are recessed to help prevent moisture from getting inside. But still, a spill could damage internal circuits.

Figure 10. Lifting and Carrying the Monitor II

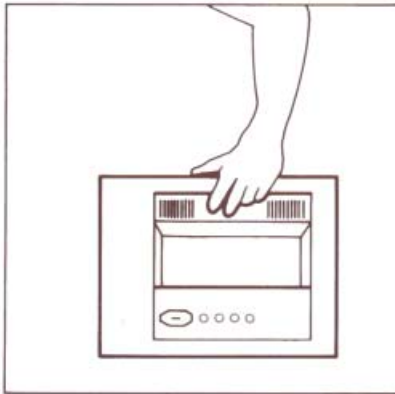

Before moving your monitor, be sure to unplug the video cable from the Monitor II and the power cable from the wall. When lifting and carrying, use the special hand recess at the top of the cabinet.

The screen of the monitor is quite rugged. But still, it's a good idea not to lay the monitor face down, to avoid scratching it.

Like TV screens, monitor screens attract dust because of static electricity, and built-up dust makes for uncomfortable viewing. An occasional wipe with a dry, lint-free cloth will help keep your monitor's screen clean.









Avoid smearing or smudging the screen with your fingers. The oil from your fingertips will make dust adhere to the screen.

Your monitor's screen has an etched antiglare surface, which greatly reduces eye fatigue and makes reading easy, even when light reflects from its surface.

Whenever you look for any length of time into a light source such as a TV or computer monitor, you may feel bleary-eyed. Though we have designed the screen to be comfortable for all users, you may still experience eye fatigue. If you find your eyes tiring, just look away from the screen and focus on objects at varying distances. By exercising your eye muscles in this way, you can avoid or relieve eye strain.

If All Else Fails

From time to time, your Monitor II may not behave as you expect it to. This chart should help you overcome the most common problems that may occur with your monitor. If you don't find your specific problem here, or if our remedies don't work, please contact your dealer.

Problem	Cause	Remedy
Unusual sounds or smells emanating from the monitor.	Monitor's electronics are overheating.	Unplug power and video cords immediately and contact your Apple dealer.
No picture and on/off switch is in ON position, but power light is out.	Monitor is not plugged in.	Insert power cord into the outlet properly.
	OR Bad connection to wall outlet or dead outlet.	Change outlets or check line fuse or circuit breaker.
No picture, but on/off switch is down and power light on.	Video cable is not connected properly to the  socket on the monitor or to the video out socket on the Apple.	Connect video cable properly to the  socket or video out socket on the Apple II.
	Contrast control  is turned too far one way or the other.	Turn contrast control until display appears.
	Brightness control  is turned too far one way or the other.	Turn brightness control  clockwise until display appears.
Display vibrates slightly.	Input signal from the computer needs adjustment.	There may be a problem with the computer. Contact your dealer.
Display rolls up or down.	Vertical hold control  is misadjusted.	Rotate vertical hold control  until display stabilizes.
Characters are either taller or shorter than normal.	Vertical size control  is misadjusted.	Rotate vertical size control  until display is satisfactory.

Safety Tips and Common Sense

Following these reminders will make life easier for you and your monitor:

1. To avoid electric shock, never touch the inside of the monitor. Only a qualified technician should open the monitor's case. Do not poke anything through the openings in the case. You may get an electric shock or damage the monitor.
2. Do not allow anything to rest or run against the power cord. Keep it away from where people will walk over it or trip on it.
3. If your power cord is frayed or damaged, have your dealer replace it. Don't use your monitor with damaged equipment.
4. Maintain proper clearance behind the monitor and don't drape anything over the back that might obstruct the vents. Be sure that proper air circulation is possible at all times.
5. We suggest you use your monitor, like any other sophisticated electronic equipment, in dry, low humidity areas. Moisture is the bane of delicate electronic circuits. Also, don't operate the monitor in locations where it is exposed to direct sun or other high temperature sources.

Remember, if you don't take proper care of your monitor—if you abuse it, spill liquids on it, or drop foreign objects inside—or if you open the Monitor II and try to modify it, your warranty will be void.

Specifications

A. Cathode Ray Tube (12GBY)

- | | |
|--------------------------|--|
| 1. Size: | 12 inch diagonal |
| 2. Deflection angle: | 90° |
| 3. Glass area: | 74 square inches |
| 4. Implosion protection: | Tension band with mounting lugs |
| 5. Phosphor: | P31 (green) |
| 6. Anode voltage: | 13.0 ± 0.8KV |
| 7. Display size: | 21.6cm (H) x 16cm (V) |
| 8. Faceplate: | Contrast enhanced and antireflective surface |

- B. Electrical characteristics
1. Power input: 115VAC + 5%, - 12%,
50/60Hz or 230VAC + 5%,
- 12%, 50/60Hz
 2. Power consumption: 30W under normal viewing
conditions
 3. Fusing: Internal fuse protection
 4. Video input: 0.5Vp-p to 2Vp-p synch
Negative RS-170
compatible
75 ohms internal termination
Cabinet-mounted phono
jack connection
 5. Video bandwidth: 18MHz
 6. Horizontal deflection: 15,200Hz to 16,300Hz free
running
Hold range: ± 500 Hz
Retrace time: 9.8 μ sec
Linearity within 2% of width
47Hz to 63Hz
 7. Vertical deflection: Hold range: +0 to -8Hz
Retrace time: 450 μ sec
Linearity within 2% of height
 8. Adjustment size range: Adjustable from 105% to
approx 85% of full picture
size with less than 2%
linearity change
- C. Picture quality
1. Resolution: 900TV lines at center
800TV lines at corners
 2. Linearity: Less than 10% for adjacent
characters
Less than 20% for any two
characters on the entire
display field
 3. Display capability: 80 characters/row, 24 rows

D. Controls

1. Front:

On/off switch

Contrast

2. Back:

Input connector (RCA style
phono socket)

Vertical hold

Vertical size

Brightness

E. Mechanical and environmental

1. External dimensions:

Width: 37cm (14 9/16")

Height: 27cm (10 5/8")

Depth: 31.8cm (12 1/2")

2. Weight:

Approx 8.5kg

3. Operating temperature:

+5°C through +40°C

4. Storage temperature:

-35°C through +60°C



20525 Mariani Avenue
Cupertino, California 95014
(408) 996-1010
TLX 171-576

030-0598-A